

**to see with different eyes.**

products for the visually impaired - Development - Production - Sales

Visio  
Braille

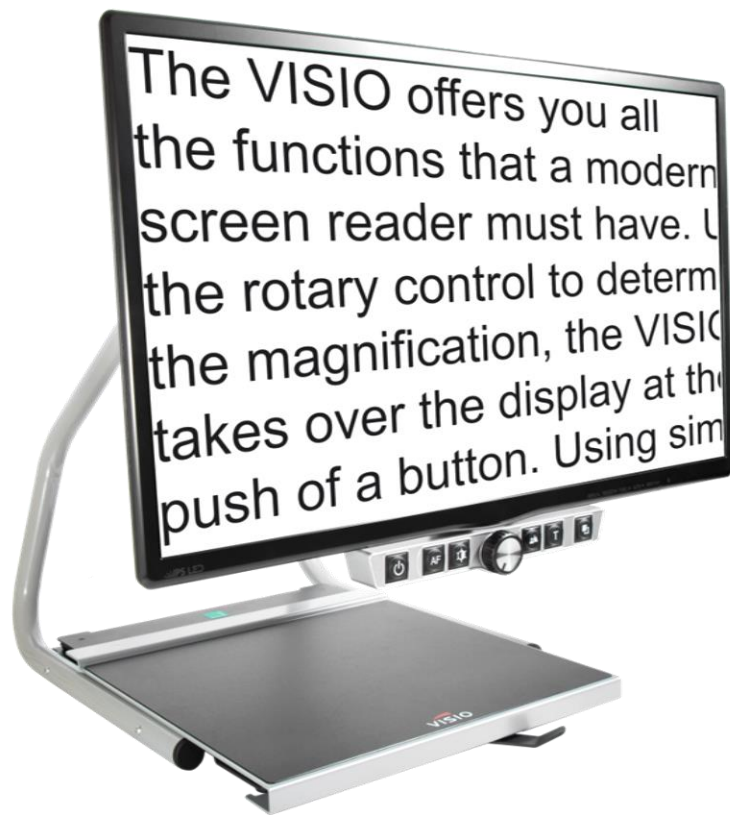

# Visio 24

## User Guide

Version 3

English 10/2021

# VisioBraille - see with different eyes

VisioBraille GmbH is convinced of the screen-reading devices as VISIO family, the VARIO braille displays and Poet reading devices!

With these innovative tools we want balancing the restrictions of blind and visually impaired people as best as possible, strengthening their independence and providing assistance on the way to an independently designed everyday life.

This goal is achieved through our high level of commitment in the development of high-quality products. Many years of experience in this area, excellent know-how and the aid of the most modern technologies, improve the livability of our customers significantly.

Ergonomics, design and quality of the products developed and produced in Germany meet the highest demands.

Both in the private sector, as well as in training and at work, you can overcome barriers by using our high-quality products, and drive your success further.

# Contents

<b>1</b>	<b>ABOUT THIS USER GUIDE.....</b>	<b>4</b>
<b>2</b>	<b>ABOUT VISIO 24.....</b>	<b>5</b>
<b>3</b>	<b>BEFORE SWITCHING ON FOR THE FIRST TIME .....</b>	<b>6</b>
	3.1 EQUIPMENT / ITEMS DELIVERED: .....	6
<b>4</b>	<b>SETTING UP THE VISIO 24 ON THE TABLE .....</b>	<b>7</b>
<b>5</b>	<b>SWITCHING ON FOR THE VERY FIRST TIME AFTER ASSEMBLY .....</b>	<b>8</b>
<b>6</b>	<b>THE CONTROL UNIT OF VISIO 24.....</b>	<b>10</b>
<b>7</b>	<b>BRIEF OVERVIEW OF THE CONTROLS.....</b>	<b>11</b>
<b>8</b>	<b>GET TO KNOW YOUR NEW VISIO 24 .....</b>	<b>12</b>
<b>9</b>	<b>TROUBLESHOOTING.....</b>	<b>18</b>
<b>10</b>	<b>DEFECTS AND REPAIR.....</b>	<b>20</b>
<b>11</b>	<b>SERVICE BOX.....</b>	<b>21</b>
<b>12</b>	<b>COMPLIANCES.....</b>	<b>22</b>
	12.1 CE KONFORMITÄT .....	22
	12.2 FCC CONFORMITY .....	22
	12.3 ENVIRONMENTALLY FRIENDLY DISPOSAL ACCORDING TO EU-DIRECTIVE 2012/19/EU23	
<b>13</b>	<b>WARRANTY .....</b>	<b>25</b>
<b>14</b>	<b>FOR YOUR SAFETY .....</b>	<b>26</b>
<b>15</b>	<b>TECHNICAL DATA .....</b>	<b>29</b>

# 1 About this user guide

This manual is intended for all users of VISIO 24. The device has already been set up by your dealer so that you have a fully functional device at your disposal. In this manual you will find all information required to use your VISIO 24.

The manual is a part of your device. Please read this manual with care and attention as it contains important instructions and tips with regard to operating the device and its safety. Please keep the manual always within reach of your device and do pass it on to a next owner.

**Copyright** © 2021 VisioBraille GmbH, Ossmaritzer-Strasse 4c, D - 07745 Jena, Germany. All rights reserved. No part of this publication may be reproduced or distributed in any form or by any means, or stored in a database or retrieval system, without prior written permission from VisioBraille GmbH.

All efforts have been made to ensure that information contained in this document is correct at the time of issue. Neither VisioBraille GmbH nor its representatives assume any responsibility for errors or omissions. Nor is any liability assumed for damages resulting from the use of information contained herein.

## **Licenses and trade marks**

All licenses and trade marks are the property of their respective owners.

## 2 About VISIO 24

Attractive design, simple operation, excellent image quality - that's what VISIO 24 stands for.

Visio 24 has a high-resolution camera and a 24 "widescreen monitor in 16:9 format with energy-saving and high-contrast LED lighting. The high resolution of the camera ensures a razor-sharp image even at the smallest magnification.

The VISIO 24 has a XY-table and a color camera, also has 6 control buttons and offers an extremely wide range of functions such as an adjustable reading line.

VISIO 24 is one of the one of the smallest, lightweight and best designed devices. It is characterized by its extraordinary design. VISIO 24 has all the properties you would expect from an excellent screen-reading device.

In addition to full color display and autofocus, VISIO 24 has numerous false color display options. Reversal of foreground and background color is of course also available. There is also the option to switch off the auto focus, e.g. to fill out forms or to make handwritten notes. Thanks to the image optimization function, VISIO 24 always offers optimal image quality.

VISIO 24 is able to display even documents of very poor quality, such as pale print or crumpled, dirty paper, in a legible manner on the screen. Despite the high technical effort, it can happen that in rare cases an original cannot be displayed more legibly, e.g. with highly reflective reading material.

# 3 BEFORE SWITCHING ON FOR THE FIRST TIME

Please read the safety instructions at the end of this manual and check that the scope of delivery is correct.

## 3.1 Equipment / Items delivered:

- 1 VISIO 24 screen-reading device
- 1 AC-Adapter
- 1 power line cable
- 1 handbook
- 1 assembly guide

## 4 Setting up the VISIO 24 on the table

Place your VISIO 24 on your table in such a way that the front edge of the XY-table, which has been fully extended to the front, is just flush with the edge of the table. Even with maximum movement of the XY-table to the left or right, it must not protrude over one of the table edges. This ensures that the device is in a safe position.

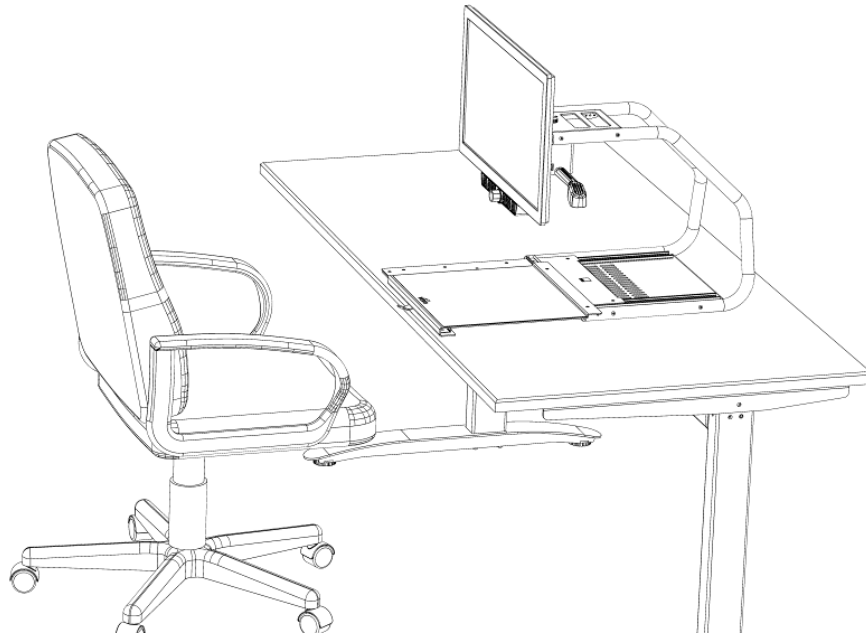

Picture 1

## 5 Switching on for the very first time after assembly

You can skip this chapter, as the following steps were usually carried out when the device was delivered and are only mentioned here for the sake of completeness.

Connect the power pack of your VISIO 24 to a live power socket and the plug on the other side of the power pack into the camera unit. The power supply input (see Figure 2) is on the right-hand side of the camera unit. The ready LED lights up immediately after plugging in and lights up continuously.

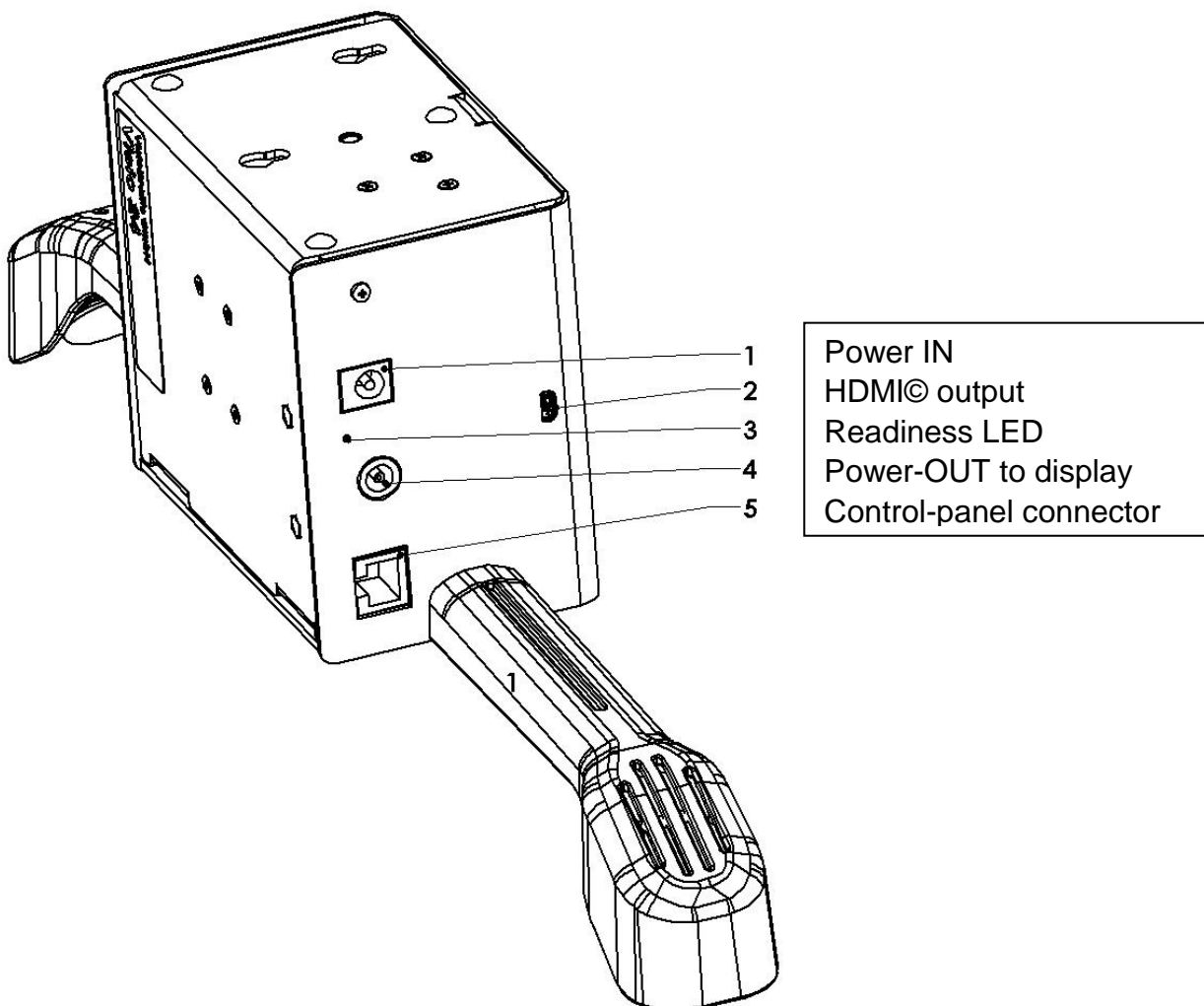

Picture 2



Press the power switch  on the far left of the control unit below the monitor for about a second. As soon as the lighting switches on, you can release the switch. The monitor also switches on immediately. (Note: The white control lamp on the right at the lower edge of the monitor lights up continuously.)

If necessary, the power-on-switch of the monitor is directly under the control lamp. You can place your finger on the lower right edge of the screen and move it to the left until you feel the slight bump of the power button. After pressing this button, the power-on control lamp lights up white. VISIO 24 from now automatically switches on the monitor.

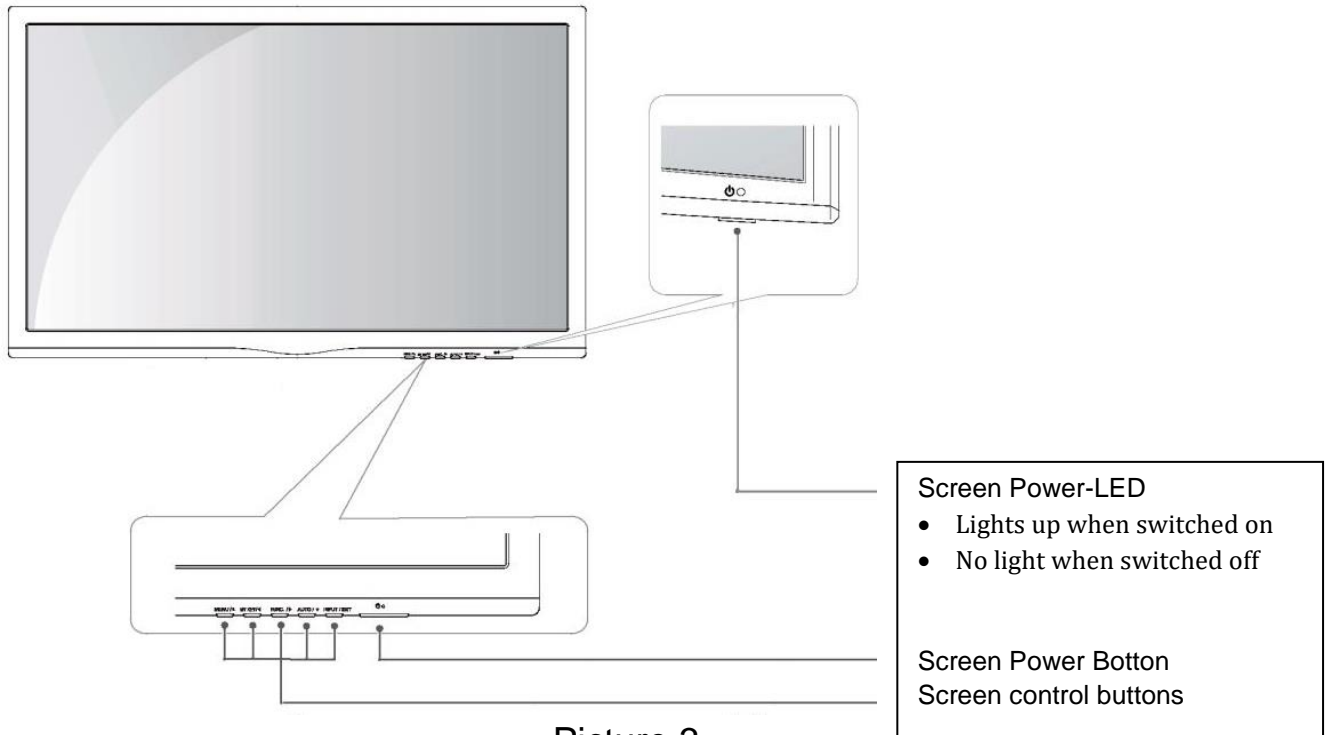

Picture 3





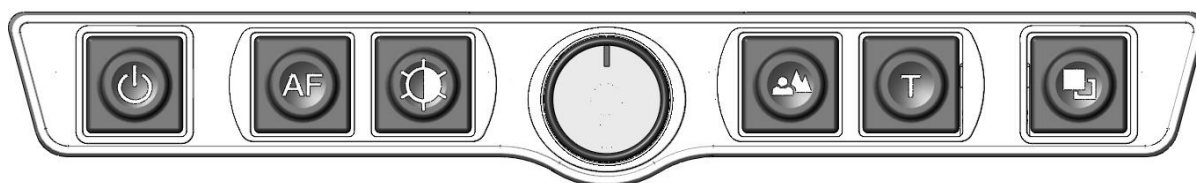

These steps only need to be done when switching on for the first time after delivery. Then it is sufficient to switch VISIO 24 on and off on its control unit.

## 6 The control panel of VISIO 24



Picture 4

## 7 Brief overview of the controls

	<p><b>Power button</b> Press for about 1 second (until lighting comes on) to switch on the device. Long press to turn off.</p>
	<p><b>Autofocus</b> Switches between auto focus on and off. An autofocus always has a sharp image. Auto focus off when taking handwritten notes.</p>
	<p><b>Image optimization</b> Switches between the 5 image optimization levels. Improves the image quality with difficult originals.</p>
	<p><b>Zoom / Enlargement &amp; Reading Line / Reading Gap</b> Turning to the left reduces the magnification, Turning to the right increases it.</p> <p>Pressing it briefly shows the reading line. Repeated short presses hide the reading line again.</p> <p>A long press shows the reading gap. Repeated long presses hide the reading gap again.</p>
	<p><b>Picture</b> View pictures or documents in real color. Also recommended for reading documents with poor print quality.</p>
	<p><b>Text – inversion</b> Use text mode to read. The contrast is greatly increased so that you can read more relaxed. Press the key again to reverse the foreground color and background color.</p>
	<p><b>False colors</b> In text mode: Press this button to choose between the 12 false color displays. (The text key reverses the foreground and background) In picture mode: white balance - neutral white, warm red tone, cold bluewhite.</p>

## 8 Get to know your new VISIO 24

You have already learned how to set up VISIO 24 optimally on your table and how to supply VISIO 24 with power.

You can tilt the screen slightly for more comfortable reading. Do not try to tilt the screen too far by going past the stop.

VISIO 24 has a height adjustment of the screen!

Move the monitor up and down together with the control panel. You do not need any tools for this.

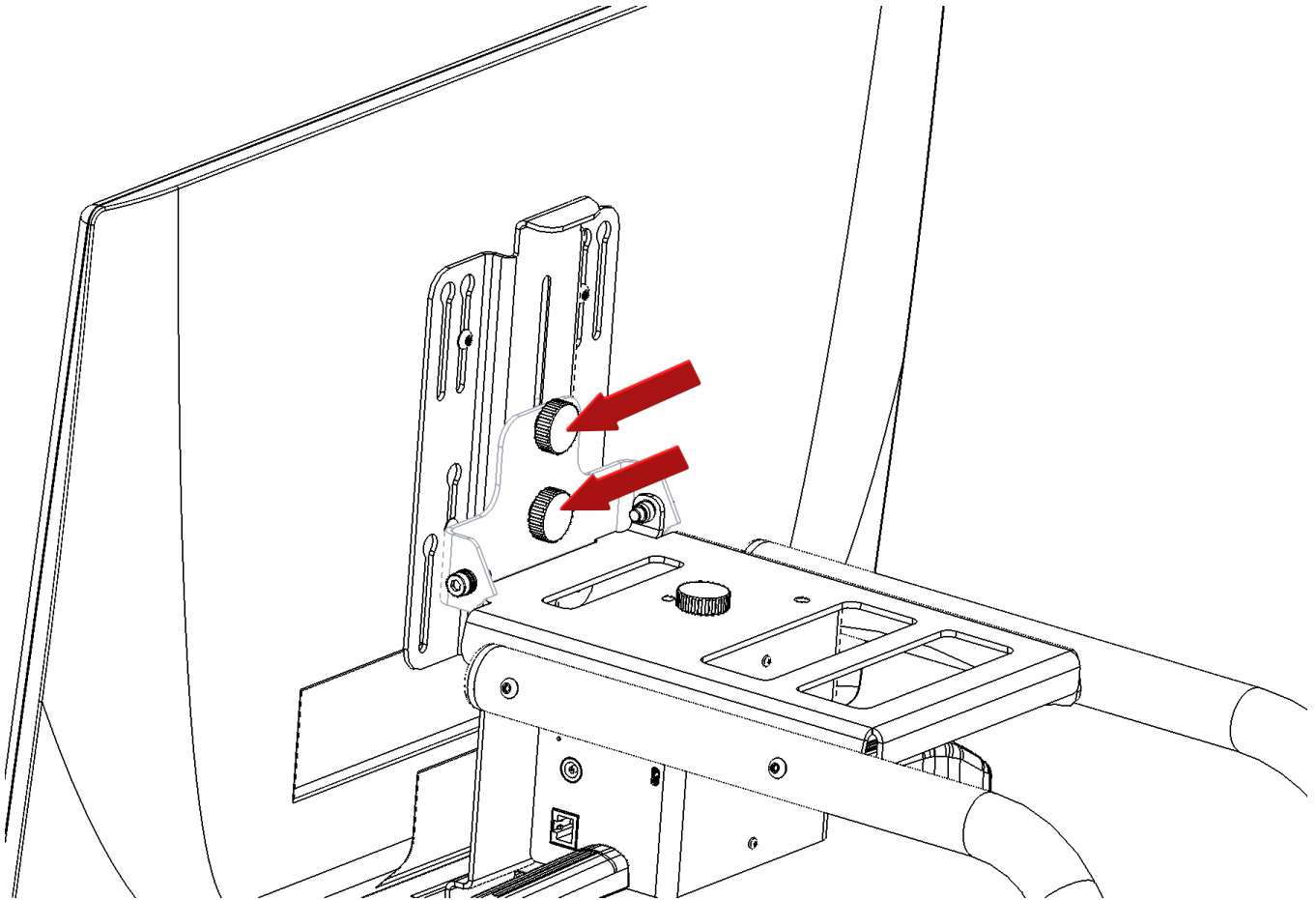

Picture 5

Proceed as follows:

[Important: always keep one hand at the bottom of the monitor]

Tilt the monitor back slightly.

Turn the two fixing screws (see arrows in Figure 5) on the back of the monitor half a turn to the left.

Grasp the top and bottom of the monitor and slide it to the desired height.

Tighten the two fixing screws again to the right.

Now switch on VISIO 24 to use it.

The **control unit** is located directly in the middle under the screen. The **on-switch** is on the far left. Press the power button for about a second to turn on the device. As soon as the lights come on, you can let go of the switch. The monitor may display the message like "out of range ..." until you see the enlarged original on the screen after a few seconds.

To switch off VISIO 24, you have to press the on switch for longer than a second. This prevents you from switching off the VISIO 24 by accidentally briefly touching the switch. Practice turning it on and off a few times, then leave it on for the next few steps.

Place a template on the **XY-table**. Take something colored, maybe a brochure or magazine with text and colored pictures.

To align the template exactly horizontally, push it back against the silver rear edge of the XY-table. If you now slide the XY-table from left to right, you will not slip in the line, as the template aligns itself on the edge parallel to the guide direction. This little trick will make your reading a lot easier.

The XY-table has a brake for locking. You will find the brake lever on the front edge of the XY-table. Move the lever all the way to the left to be able to move the XY-table freely in all directions. With the lever in the middle position, you can move the XY-table slightly to the right and left; the movement to the front and back is blocked. In the rightmost position, the table is firmly locked in all directions.

Now align your template with the rear edge of the XY-table and move the brake lever all the way to the left.

 **Attention:** Avoid getting your fingers or clothing into the mechanics of the XY-table below the reading plate to prevent them from being trapped. Keep your hands above the plate or on the front edge. Do not reach under the side or rear edges of the reading plate.

Now let's try the buttons on the control unit. You already know the on-switch on the far left of the control unit.

There is a round knob in the middle of the control unit. This is the **zoom or magnification slider** that you use to adjust the magnification. Turning clockwise increases the magnification, turning counterclockwise decreases it. Now turn the zoom control counterclockwise as far as it will go to minimum magnification.

The minimum enlargement level is less for reading and more for providing an overview of the original. This makes it easier for you to find the area that you want to look at enlarged. Visio 24 always starts at the last zoom level set.

Now press the Image button. The **Image button** is located directly to the right of the zoom slider. Pressing the image button switches on the real color display, i.e. the VISIO 24 image mode. This setting is ideal for viewing photos, but it is also useful for reading documents that are of poor print quality. You see all colors and gray values in a natural representation.

Now move the XY-table so that you can see one of the images of the template. If the image is too small, you can increase the magnification by rotating the zoom lever clockwise. If you got "lost" on the template because you accidentally moved the template, turn the zoom control counterclockwise to a smaller magnification, look for the correct position in this overview and then enlarge the image again.

Now that you have learned a lot about your new VISIO 24, let's read a text.

Move the XY-table to a point on the template where you can find related text. Now press the text button. The Text button is to the right of the Image button, i.e. the second button to the right of the zoom controller. The original is now displayed with increased contrast and only two false colors. Press the Text button again to swap the foreground color and background color. Press the Text button a few times to familiarize yourself with the changes to the display and also toggle between image display and text display. Do you know the difference? In text mode, the font appears much clearer and richer in contrast, in picture mode you can see all the colors and gray values.

Don't like the two colors in text mode? No problem!

You have the choice between 12 different false color combinations. With the inversion, i.e. reversing the foreground and background color, you have a choice of 24 different representations. Select a different color combination by pressing the

**false color key.** This is the rightmost button on the control unit. Each time you press this button, the color combination changes. When you have done all 12 combinations, it starts again with the first one. To swap the foreground and background color, press the text key.

The following color combinations are available:

Black-White, Black-Yellow, Black-Green, Black-Magenta, Black-Cyan, Blue-Yellow, Blue-White, Black-Ivory, Black-Soft\_Yellow, Black-Soft\_Peach, Black-Soft\_Pink, Blue-Ivory

Select your preferred color combination with the false color key and, if necessary, press the text key to swap the foreground and background color. Take the time to find the setting that works best for you.

In picture mode, the false color key has a different function. Here you can change the white balance. Press this button to toggle between a neutral white (default setting), a warm shade of red, which is good for viewing photos with skin tones, or a cool blue and white, which is especially suitable for reading colored text.

**Note:** VISIO 24 remembers the setting of the false colors. So if you switch from text mode to picture mode and then return to text mode, you will find the previously set color combination and inversion there.

Now that you have found your preferred color setting for reading in text mode, we now want to turn to the more problematic templates. In most cases, VISIO 24 will display your enlarged original with good contrast, thanks to its automatic exposure. This is also easy with clean, black printing on pure white paper.

Sometimes it happens, however, that the template is not ideal and the automatic system does not find the best setting. This can happen, for example, with colored writing or a colored background, or with poor photocopies with pale letters on gray paper. In these cases we use the **image optimization** button. It's the third button from the left, just to the left of the zoom controller. With this button you can regulate the automatic capture range in five stages.

So if you ever get a poorly legible picture from VISIO 24, simply press this button until the picture is best represented.

This button is effective in picture mode and text mode.

**Note:** Often you just know that the last setting was the best when you are already one too far and the picture gets worse again. Since there are five different settings that run up and down, you only need to press the button seven times in succession to return to the previous setting.

Another help to find your way around a text is the **reading line**.

To activate the reading line, first set the desired magnification on the magnification control.

Now press the center of the magnification control and release it shortly afterwards. You will notice that a black horizontal line is now displayed over the picture on the screen.

You can now adjust this reading line with the magnification control clockwise upwards and counterclockwise downwards, the magnification does not change.

You can hide the reading line again by briefly pressing the magnification control repeatedly.

**Reading gap** feature is used to hide the image area above and below a line to be read and is activated by pressing and holding the zoom control. When you are in picture mode and have set the desired magnification, press the magnification control for about a second and release it than.

A reading gap is now shown in the middle of the screen. You can adjust the width of this reading gap to your needs using the magnification control. To widen the reading line, turn the magnification control to the right; to display it more narrowly, turn the magnification control to the left.

The rest of the picture is black. You can hide the reading gap by pressing the zoom control again for about a second.

**Note:** The reading line and reading gap can also be displayed in all false color modes. In addition, the reading line adapts to the false colors. For example, if you set yellow font and black background, the reading line is automatically yellow. You can also display the colored reading line in real color mode by pressing the image button. After restarting the Visio 24, the reading line color is always black.

Now we will explain the function of the **autofocus button**. It may sound complicated, but it is very easy!

After switching on, the autofocus, i.e. automatic focusing, is always switched on. This means, no matter how thick the book you want to read, or how curved its surface, VISIO 24 always shows the enlarged section in focus. This is why you will usually work with this setting.



Sometimes, however, you want to fill out a form or a crossword puzzle, you may also want to paint your fingernails or take a closer look at a 3-dimensional object. This is where the fixed focus comes into play.

The autofocus button is the second from the left on the control unit. If you press this, you switch the autofocus between on and off.

Now let's try how it works. If you've messed around with this button, press the autofocus button once and turn the zoom control a little to the right.

VISIO 24 enlarges the original and focuses it automatically.

If this is not the case, press the autofocus button repeatedly and the VISIO 24 will focus the original.

Now place your hand on the template. VISIO 24 now enlarges your hand and you can see that your skin is now in focus and the letters at the edge are blurred. The same thing can happen when you want to fill out a form. Instead of making the letters sharp, it is possible that your hand, which is holding the pen, is sharp and the letters are blurred. If you take your hand away, the letters become sharp again.

Now let's try the same thing with the autofocus off. To do this, place a form on the XY-table. You can see that the letters are sharp, press the autofocus button again to switch it off. If you now fill in the form with a pen, VISIO 24 will still keep the letters in focus and will no longer focus your hand. When you're done, don't forget to turn the autofocus back on with the autofocus button.

An additional feature of your Visio 24 is to switch itself off after 4 hours without use. Should you accidentally not switch off your Visio 24, it will switch off itself after this time.

You did it! You are now familiar with all the setting options and functions of VISIO 24.

We hope you enjoy your new VISIO 24 CCTV device.

## 9 Troubleshooting

So now it happened. VISIO 24 does not work as expected and you are clueless if it is broken. Very often, a small reason can cause a big problem, which can be resolved easily. So please read the following checklist and try to find out what is wrong. If this does not help, please switch VISIO 24 off, unplug the power cable from mains and contact our service department.

### **Display and lights remain dark**

Please try to switch VISIO on again. If this does not help, make sure power supply is connected to both the VISIO and wall outlet and that wall outlet is live. You may want to connect another device to the wall outlet to check.

Are all plugs seated properly in their sockets?

### **Only display remains dark, lights are on**

Is the light in the display's lower right edge on? Is it red?

If not, switch VISIO 24 off and on again or press the sensor button in lower right edge of display. Best you touch the edge and move your finger leftwards. Now the light should be on and redd.

If not, please check if power cable in back of display is seated properly. At VISIO 24, the short power supply cable for the display comes out of the camera housing behind the display.

### **Image is blurred**

Check if protective plastic foil is still covering camera lens (remove this foil) or whether this lens is dirty. If so, clean with a dry, soft cloth.

Turn zoom knob clockwise in middle position.

### **Document cannot be read**

Turn zoom knob clockwise.

Try different setting of Image optimizer button.

### **XY-Table is not moving**

Move lever to leftmost position.

### **Letters are fluttering**

Increase zoom by turning zoom knob clockwise.

Try different settings of Image optimizer button.



# 10 Defects and Repair

If VISIO 24 is broken – what to do?

- Did you check all settings and connections according to the manual?
- Did you remove the protective plastic film from the camera lens?
- Are you sure the mains outlet is live?

Do not use a broken device! Unplug broken device from mains! Please do not hesitate to contact your local distributor or VisioBraille GmbH.

You can reach VisioBraille GmbH at telephone number +49 (0) 3641 2816-400 in Germany. We will help you check your VISIO 24 and in case it is broken we can mail a service box for shipping VISIO 24 to our repairs department. Show this manual to the person who will help you packing VISIO 24 in the service box.

## **Contact:**

VisioBraille GmbH  
Ossmaritzer-Strasse 4c  
D-07745 Jena  
Germany

Phone: +49 (0) 3641 2816-400

Web: [www.visiobraille.de](http://www.visiobraille.de)

Email: [info@visiobraille.de](mailto:info@visiobraille.de)

Email Service: [service@visiobraille.de](mailto:service@visiobraille.de)

# 11 Service box

For shipping VISIO 24 in the service box, proceed as follows:

- Switch off VISIO 24
- Unplug from mains
- Put display in upright position, fasten brake of XY-table
- Remove white foam parts and corrugated card board cover from box.
- Cover left and right side of display with foam parts.
- Hold VISIO 24 on handle on upper side and put it in service box. Only fits in one direction into pre-shaped bottom space (see image).
- Insert corrugated card board cover on top and put power supply in smaller pocket.
- Close box.

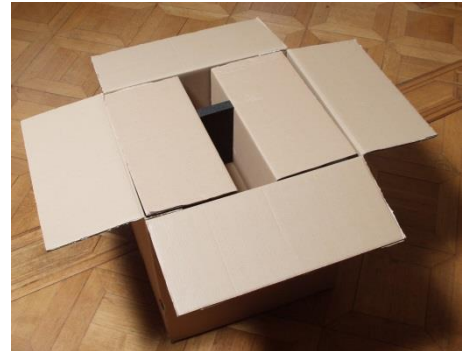

# 12 Compliances

## 12.1 CE Conformity

This product conforms to the guidelines of the European Union and takes the CE- and ROHS Marking



## 12.2 FCC Conformity

1. This device complies with Part 15 of the FCC Rules. Operation is subject to the following two conditions:
  - (1) This device may not cause harmful interference, and
  - (2) This device must accept any interference received, including interference's that may cause undesirable operation
  
2. Changes or modifications not expressly approved by the party responsible for compliance could void the user's authority to operate the equipment.



**NOTE:** This equipment has been tested and found to comply with the limits for a Class A digital device, pursuant to Part 15 of the FCC Roles. These limits are designed to provide reasonable protection against harmful interference in a residential installation.

## 12.3 Environmentally friendly disposal according to EU-Directive 2012/19/EU

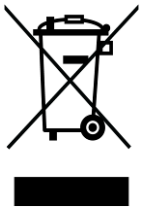

The symbol (crossed garbage can), which is also attached to the device, states that this device and its accessories, once come to the end of its lifetime, should not be regarded as household waste. An environmentally friendly way of final disposal is compulsory.

This device contains electronic components. In order to avoid risks or dangers for the environment through non-professional waste disposal, the disposal of this device and its accessories must correspond to the valid EC-Directives or other local regulations. Please check your local regulations for proper disposing of this device or consult your local distributor.

For data privacy protection reasons, please remove all personal data from the device prior to disposal.

**EU Konformitätserklärung**  
*EU Declaration of Conformity*

**Wir, die Firma**  
*We, the company*

**VisioBraille GmbH**  
Ossmaritzer Str. 4c  
07745 Jena  
Germany

**erklären in alleiniger Verantwortung, dass das weiter unten genannte Produkt**  
*declare under our sole responsibility that the following product*

Geräteart/ <i>Type of product:</i>		Elektrische Lesehilfe / <i>reading aid</i>
Handelsmarke/ <i>Trademark:</i>		VisioBraille
Modell <i>Model</i>	Artikelnummer <i>Article-no</i>	weitere Angaben <i>further details</i>
Visio24	-	keine Batterie / <i>not battery operated</i>

**die grundlegenden Anforderungen der aufgeführten EU-Richtlinien erfüllt:**

2014/30/EU	Richtlinie über die elektromagnetische Verträglichkeit
2011/65/EU	Richtlinie zur Beschränkung bestimmter gefährlicher Stoffe in Elektro- und Elektronikgeräten

*meets the essential requirements of the following EU-Directives:*

2014/30/EU	<i>Directive on Electromagnetic Compatibility</i>
2011/65/EU	<i>Directive on the restriction of the use of certain hazardous substances in electrical and electronic equipment</i>

**angewandte Standards und Verordnungen/*applied standards and regulations:***

EN 55024:2010  
EN 55032:2015  
EN 55035:2017  
EN 50581:2012

**Bevollmächtigter zur Zusammenstellung der technischen Unterlagen:**  
*Authorized person for technical documentation:*

Name/*Name*, Position: Thomas Lucas, CEO

Jena, 07.07.2021  
Datum/*Date*

  
Unterschrift/*Signature*



# 13 Warranty

VisioBraille GmbH warrants the device, effective from the date of delivery, to be free of any defects in material and workmanship. Warranty is not transferable and does not apply to groups, multi users or agencies. This device has been designed for the individual purchaser to be used in home or office environments. VisioBraille GmbH reserves the right to repair or replace with a similar or better product. In no event shall VisioBraille GmbH or its distributors be liable for indirect or consequential damages. The original users' remedies are limited to replacement of devices modules/parts. This warranty is valid only when service is done in the country of original purchase and with intact warranty seals. For additional warranty claims or service during or after warranty period, please refer to your local distributor. VisioBraille GmbH does not take responsibility for use of this device other than described in this Manual.

- Warranty on new devices is 24 months.
- Warranty on used or refurbished devices is 12 months.
- Warranty on Consumable parts (Batteries, Braille Pins, Data carriers etc.) is 6 months.
- Warranty on storage media (SD-cards, CD-ROMS, DVD's, etc.) is 90 days.
- Warranty on repairs and spare parts is 12 months.

All defects caused by improper use or users fault are not covered by this warranty.

Warranty will be void if warranty seal is damaged.

Parts replaced during repair are transferred into ownership of VisioBraille GmbH and will not be returned to the customer.

In case of repair the device must be properly packed into its original shipping box.

Costs for packing, shipping and insurance are not covered by VisioBraille GmbH.

# 14 For your safety

 **Important note:** Failure to observe the following warnings may invalidate the guarantee and could cause damage of the device or serious injury.

Please check contents of package before you use the device. If parts are damaged or missing, please do not hesitate to inform your dealer.

Please keep the shipping box, so you can safely pack the device in case you have to ship it for service, etc. Improper packaging could cause loss of warranty. In case you need a new shipping box, your dealer can send you one.

Please carefully read the user guide and safety instructions before you use the device for the first time.

This device may only be used in a home or office environment.

Do not place on an instable surface. It may fall causing serious damage to the device or injury to the user. Please follow the instruction on how to place the device especially in respect to avoidance of tilting and falling down by keeping proper space to edges of table.

Visio contains moving parts. Please take care when adjusting the display or moving the arms to fold the device. Injury may occur if fingers or clothing are caught in the operating mechanism. If you have difficulties in operating the unit safely, please seek advice or contact your local dealer.

Connect the power supply to a grounding-type power outlet only.

Do not use the device if you find any damages at device or wires.

If the device appears to be operating abnormally, or to be damaged in any way, please contact your VisioBraille GmbH dealer as soon as possible.

If you smell smoke or an odor coming out of the device, turn off the power immediately.

Do not try to repair the device yourself. Opening or removal of housing may cause damage or injury.

Do not allow sand or dust to come into contact with the device as this may lead to serious damage and could make repair impossible.

Use the device with clean hands only.

Do not use in locations where strong radio waves are emitted or where there is radiation. Keep a distance of at least 30cm to mobile phones.

Only use original accessories. Use of second source accessories may damage the device or cause malfunction or safety issues.

Do not use a power supply not made for this device. Only use the original power supply!

Do not use the power supply with other devices.

Avoid liquids and food near the device.

Do not use or store the device in any of the following places as this may cause damage:

- Inside cars parked with the windows closed in the hot sun.
- In direct sunlight or close to heaters, radiators, etc.
- Locations subject to severe vibration such as on top of a washing machine.
- Locations subject to strong magnetism such as near loudspeakers.
- Humid places (bath room), in water, or near water.
- In rain or snow
- Do not use or store below 0°C or above 40°C.
- Humidity shall be within 20% to 80%
- Avoid fast temperature changes

If you bring the device from cold places into a warm room, humidity may condensate. Wait until the device is dry and well-tempered to room temperature before use.

Unplug from mains before cleaning.

Wipe dust and dirt from the device with a soft cloth dampened with a diluted neutral detergent, then wipe dry with a cloth. Do not bring in contact with water.

Do not insert objects into openings.

Do not use device during thunderstorms. Unplug from mains during thunderstorms. We recommend use of an overvoltage protection adapter, which can be bought from your local electro store. Please note, this does not provide a 100% protection from overvoltage.

Do not insert or remove the plug with wet hands.

Do not heat in a microwave oven, on a cooker or similar.

Never disassemble, attempt to repair or modify device yourself.

If liquids or metal fragments should enter device, switch it off and remove the power lead immediately.

Do not pull the plug out by the lead when removing the power plug.

Avoid shock. Do not throw or let fall.

Repairs may only be carried out by VisioBraille GmbH or by VisioBraille GmbH authorized companies.

## **Care and maintenance**

Avoid damp and water.

Use only a clean, dry cloth to clean the housing of the device. Do not use any cleaning fluids or solvents. Wipe dust and dirt from the housing of the device with a soft cloth dampened with a diluted neutral detergent (stay clear from the Braille cells and Roll-bars!), then wipe dry with a cloth. Do not attempt to clean the Braille cells and/or Roll-bars yourself. Contact your dealer for intensive and professional cleaning of your device.

Protect the device from extreme heat, e.g. from the sun, heating units, hot cars etc.

With extreme cold and frost the device becomes inoperable and must be brought slowly back to room temperature. Under no circumstances must the device be warmed up or “thawed out” in a conventional oven, microwave oven or any other heating device!

Avoid any mechanical damage to the housing or accessories.

# 15 Technical Data

- CCTV magnifying device with High-Resolution camera and widescreen display (up to 400% more Pixels as traditional CCTV's)
- Refresh rate 60 Hz
- Display diagonal 60,45 cm (24 in.) in 16:9 format
- Monitor with LED Backlight
- Maintenance-free LED reading lights
- 32 bit Full colour
- 12 False colours with enhanced contrast + Reverse image giving 24 combinations (Black-White, Black-Yellow, Black-Green, Black-Magenta, Black-Cyan, Blue-Yellow, Blue-White, Black-Ivory, Black-Soft\_Yellow, Black-Soft\_Peach, Black-Soft\_Pink, Blue-Ivory)
- Auto Focus
- Fixed focus for writing
- Automatic exposure
- Reading line and reading gap
- Zoom range approx. 2,8 to 60 times
- Lightweight design (approx. 11,5 kg (= approx. 25.4 lbs.))
- Dimensions: approx. 530 mm x 630 mm x 580 mm (= approx. 20.9 x 25 x 22.8 in.)
- Power supply: 100-240 V AC 50/60 Hz 1.7 A max.
- Power consumption: Operation / Standby: approx. 28 W / < 0,1 W
- Protection Class 1
- Indoor use only

**to see with different eyes.**

products for the visually impaired - Development - Production - Sales

Visio  
Braille

 **Manufacturer:**

VisioBraille GmbH  
Ossmaritzer-Strasse 4c  
D - 07745 Jena  
Germany

**Distributed by:**

VisioBraille GmbH  
Ossmaritzer-Strasse 4c  
D - 07745 Jena  
Germany

Phone: +49 3641 2816-400  
Fax: +49 3641 2816-416  
Email: [info@visiobraille.de](mailto:info@visiobraille.de)  
Web: [www.visiobraille.de](http://www.visiobraille.de)

Please be advised that this user guide may contain errors, and is therefore subject to being changed or updated without prior notice.